

Configuration of CPA300 and THA300

New

CE

Remote control



MODBUS System

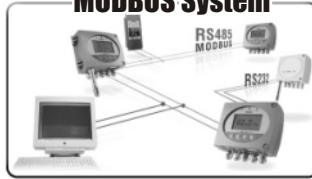

**Temperature
Humidity
< THA 300**

**Pressure
CPA 300 >**





1. Prerequisite	P 1
1.a - Working principle.....	P 1
1.b - Output signal selection.....	P 2
2. Modbus parameters	P 3
2.a - Configuration parameters.....	P 3
2.b - Modbus functions.....	P 3
2.c - Register access security key.....	P 4
3. Activation code and access to functions	P 5
4. Display configuration • F100.....	P 6
4.a - Transmitter channel for infrared remote control.....	P 6
4.b - Slave addressing (Modbus).....	P 6
5. Configuring units of measurement • F200.....	P 7
6. Analogue output management • F300.....	P 8
6.a - Output diagnostics.....	P 8
6.b - Analogue output settings.....	P 10
7. Alarm / Relay settings • F400.....	P 12
7.a - Activation / Deactivation of BEEP alarm.....	P 12
7.b - Relay security.....	P 12
7.c - Alarm / relay functions and LED colour codes.....	P 13
7.d - Channel selection for alarms / relays.....	P 13
7.e - Alarm mode details.....	P 14
7.f - Alarm mode selection.....	P 16
7.g - Setpoint and time-delay settings.....	P 17
8. Pressure measurement configuration • F500.....	P 19
8.a - Pressure measurement integration (CPA 300).....	P 19
8.b - Time-delay between 2 self-calibrations (CPA 300).....	P 19
9. Humidity measurement configuration F500.....	P 20
9.a - Humidity and temperature offset adjustment (THA 300).....	P 20
10. Air velocity measurement configuration (CPA 300 + SQR) • F600.....	P 21
10.a - Temperature compensation.....	P 21
10.b - Air velocity coefficient selection.....	P 22
10.c - Air velocity correction coefficient input.....	P 23



11. Configuration de la mesure en débit • F600	P 24
12. Other functions	P 27
12.a - Activation / Deactivation of the RS 232 and home bus	P 27
12.b - Serial number display	P 27
12.c - Modification of Modbus communication speed	P 28
12.d - Mode Purge	P 29
13. Error codes	P 31
14. Functions recap	P 32



1.a - Working principle

Using remote control / Modbus configuration, you can activate (or deactivate) a channel, change the measuring range, set the set points and time-delay...

Principle: the configuration options are accessed via **folders and sub-folders (similar to Windows®)**. Access is made via a **numerical code** (full details in this manual).

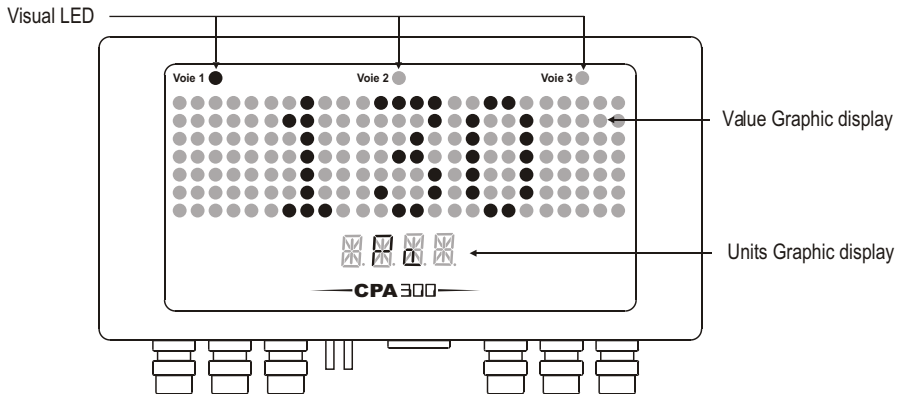

1.a.1 - Infrared remote control



■ Meaning of the remote control keys

- ⊕ To increment a value or a level
- ⊖ To decrement a value or a level
- OK To validate an input
- Esc To cancel an input or to return to the previous step

Channel selector

With this selector, you can swap the transmission channel so that it matches with the transmitter reception channel. See page 6 to configure the transmitter reception channel.



1.b - Output signal selection

Voltage or Current ?

The Class 300 can output either a **voltage** or a **current** signal.

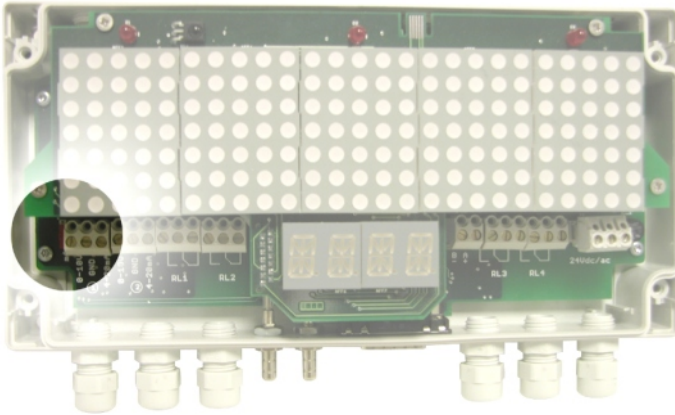

Transmitter with 24 Vac/dc power supply

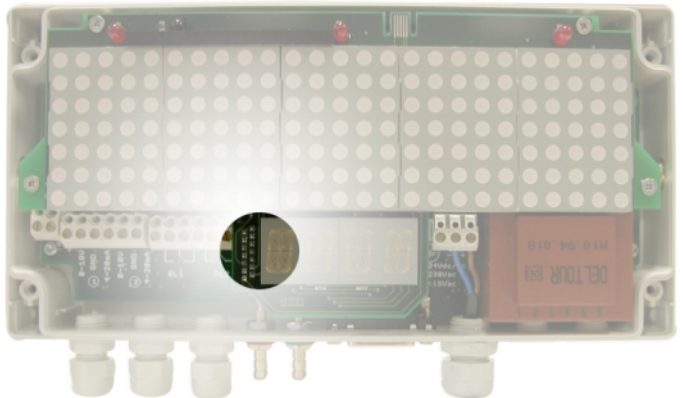

Transmitter with 230 Vac power supply (Ref. HV).



24 Vac/dc power supply model

The on-off switch is located on the left of the terminal block for transmitters with a 24 Vac/dc power supply model and on the right of the relay 1 and 2 for transmitters with a 230 Vac power supply model (Ref.HV). With the on-off switch you can choose analogue output 0-10V (voltage) or 4-20 mA (current).



230 Vac power supply model (Ref. HV)



2.a - Configuration parameters

- **communication speed** 19200 Bauds (see page 28 to configure the speed)
- **Data bits** 8 bits
- **Stop bit** 1 bit
- **Parity** None
- **Flow control** None
- **Transmitter addressing** between 1 and 255
default address "0" for single ended bus configuration (see page 6)

2.b - Functions

- **Register reading** Function 03
- **Register writing** Function 16
- **communication loop test** Function 08

2.c - Access codes to Registers

- **Registers type** Signed long integer (32 bits), permuted (LSB, MSB)

- **Alarms status** - Modbus code : 1436

For 24 Vac/dc power supply model

Ex. The value sent by the transmitter is 5
Alarm condition 1
and relay 1 excited

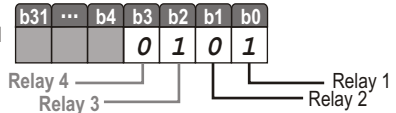

For 230 Vac power supply model
(Ref. HV)

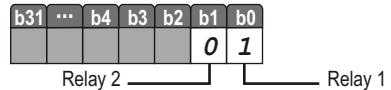

- **Values** - Modbus code : 1438 (channel 1)
1442 (channel 2)
1446 (channel 3 or value 1 of the external transmitter)
1450 (channel 4 or value 2 of the external transmitter)
Ex. the value sent by the transmitter is 6321

- **Values formatting** - Modbus code : 1440 (channel 1)
1444 (channel 2)
1448 (channel 3 or value 1 of the external transmitter)
1452 (channel 4 or value 2 of the external transmitter)

Units of measurement			
1	m/s	12	mmH ₂ O
2	fpm	13	inWg
3	m ³ /h	14	Kpa
4	L/s	15	mmHg
5	cfm	16	mbar
6	m ³ /s	17	g/kg (absolute humidity. ρ)
7	°C	18	°C (dew temp. Td)
8	°F	19	°F (dew temp. Td)
9	%RH	20	°C (wet temp. Tw)
10	PSI	21	°F (wet temp. Tw)
11	Pa	22	KJ/Kg (Enthalpy i)

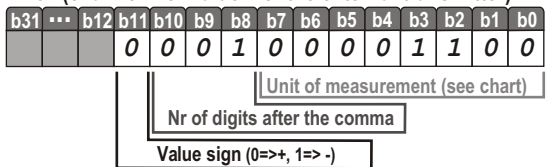

Ex. The formatting displayed is 268.
Unit of measurement => 12 (see chart)
Figure(s) after the comma => 1
Sign => positive

If the value measured is equal to 6231 :
Result => 623,1 mmH₂O



2.c - Access code to Registers (sequel)

- Serial number of sensing element (SPI - CPA 300 / Humidity - THA 300)

Modbus code : 1402

NOTE

Other access codes to different registers are indicated on each function at stage n°2.

Shown as this pictogram :



4.b - Backlight

With the Backlight, the reading is easier with more contrast. (If the ambient light is weak, you can activate or deactivate it.)

Step 1

100

Go into the configuration mode (see page 6). The folder number displayed corresponds to the last folder used.

Step 2

100

> F 101

01

Select the folder "100" and validate with

Select the sub folder "101" and validate with . The cursor goes to the line of available choices.

Step 3

> F 101

01

With and keys, select to **deactivate** the backlight or to **activate** it. Validate with

Step 4

> F 101

01

The cursor returns to the top choice line.

• press to return to reading mode.

• press once to select another folder.

• with and keys, you can choose another sub folder from the folder 100.





3. Activation code and access to functions

! This step is COMPULSORY for each configuration.

To access the transmitter functions, **and for safety**, you have to first enter a safety code.

- Please check that the transmitter is powered on.
- If the transmitter displays an error code, please see “Errors Code” section on page 31

Step 1

Press on to get this screen

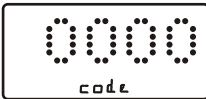

The first “0” blinks, which means that this column is activated and you can enter data from the keypad.

Step 2

Enter the CODE “0101” with the keypad and validate with

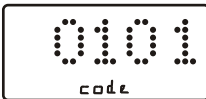

The code must be entered from left to right.
To **increment** a value or a level, press

To **decrement** a value or a level, press

To **validate a value (level) or to validate the code**, press

To return to the **previous status or to cancel**, press

Step 3

This screen appears:



This screen confirms that the code was correctly entered, and that you can **configure the transmitter**.

If the code was wrongly entered, the transmitter initializes and returns to the starting display.



Configuration folder number

The transmitter includes **6 folders** maximum :

- 100
- 200
- 300
- 400
- 500
- 600

Ex. In the folder 400, you can configure the alarms and relays. See page 12.

Step 4

Configuration folder selection

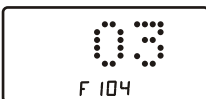

To select your configuration folder, press to increment 100 or press to decrement 100.

Once the folder is selected, press to validate.

On the top left of each page of this manual, you can find a reminder of the configuration folder where the function is available.

F400



4.a - Transmitter channel for infrared remote control



You can change the channel number for receiving the signal from the infrared remote control.

The advantage is that only one remote control is required to drive several transmitters, and that there is no interference if 2 transmitters are located side by side.

NOTE By default, the channel number is 0.

Step 1



Go into the configuration mode (see page 5). The folder number displayed corresponds to the last configuration folder used.

Select the folder "100" and validate with **OK**.

Step 2



Select the sub-folder "100" and validate with **OK**.
The cursor **>** goes to the line of available choices.



Step 3

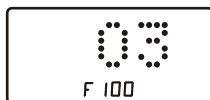

With **+** and **-** keys, select the channel number (from 00 to 99).
Validate with **OK**.

Step 4

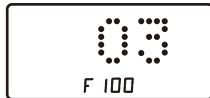

The cursor **>** returns to sub-folders line.

- press twice **Esc** to return to reading mode
- press once **Esc** to select another folder.
- with **+** and **-** keys, you can choose another sub-folder from the folder 100.

4.b - Slave addressing (Modbus)

Step 1



Go into configuration mode (see page 5). The folder number displayed corresponds to the last configuration folder used.

Select the folder "100" and validate with **OK**.

Step 2

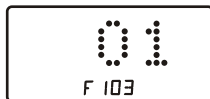

Select the sub-folder "103" and validate with **OK**.
The cursor **>** goes to available choices.



Step 3

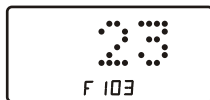

With **+** and **-** keys, set the slave addressing number (from 1 to 255).
Validate with **OK**.

Step 4



The cursor **>** goes to sub-folders line.

- press twice **Esc** to return to reading mode.
- press once **Esc** to return to another folder selection.
- with **+** and **-** keys to choose another sub-folder from the folder 100.



F200

5. Configuring channels and units of measurement

Class 300 transmitters have 4 measuring channels. You can activate 1, 2, 3 or 4 channels and select each unit of measurement.

Step 1



Go into configuration mode (see page 5). The folder number displayed corresponds to the last configuration folder used. Select the folder "200" and validate with **OK**.

Step 2



Select sub-folder and validate with **OK**. The cursor \triangleright goes to choices ligne.

Channel 1	Channel 2	Channel 3	Channel 4
200	201	202	203

Step 3



With **+** and **-** keys, select the unit of measurement (see chart below). Validate with **OK**.

	CPA301, 302 et 303 CPA301HV, 302HV et 303HV	CPA304 CPA304HV	THA300 THA300HV
00	Inactive channel	Inactive channel	Inactive channel
01	Pa	Pa	°C
02	mmH ₂ O	mmH ₂ O	°F
03	inWg	inWg	%HR
04	mbar	mbar	g/Kg (Hygro. absolue p)
05	m/s	mmHg	°C (Temp. de rosée Td)
06	fpm	m/s	°F (Temp. de rosée Td)
07	m ³ /h	fpm	°C (Temp. humide Tw)
08	L/s	m ³ /h	°F (Temp. humide Tw)
09	cfm	L/s	KJ/Kg (Enthalpie I)
10	m ³ /s	cfm	
11		m ³ /s	



For a CPA 300 transmitter (301, 302, 303 and 304 or 301HV, 302HV, 303HV et 304HV), the **SQR** option is required in order to activate the units of air velocity and airflow.

Step 4



The cursor \triangleright returns to sub-folders line.

- press twice **ESC** to return to reading mode.
- press once **ESC** to return to another folder selection.
- with **+** and **-** keys to choose another sub-folder from the folder 200.



6.a - Output diagnostics

With this function, you can check with a multimeter (or a regulator/display, or a PLC/BMS) if the transmitter outputs are working properly. The transmitter generates a voltage of 0 V, 5 V and 10 V or a current of 4 mA, 12 mA and 20 mA.

6.a.1 - Multimeter connection configuration

Before carrying out the output diagnostics, all connections and configurations of the transmitter must be enabled, to avoid any damage on the transmitter and the multimeter!

Step 1

Selection of the channel to be checked

First, **select a channel** for the output diagnostics.

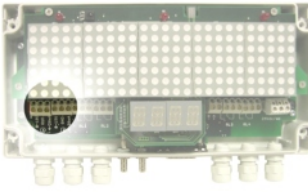

Transmitter with 24 Vac/dc power supply

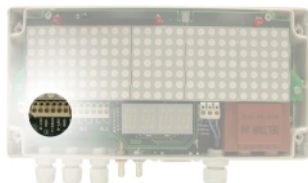

Transmitter with 230 Vac power supply (Ref. HV)

The Channel numbers are indicated on the board located below the terminal block.

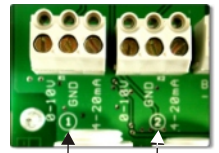

Channel n°1 Channel n°2

Step 2

Example of connection

On the opposite pictures, multimeters are plugged on the 0-10V output of the channel 1.

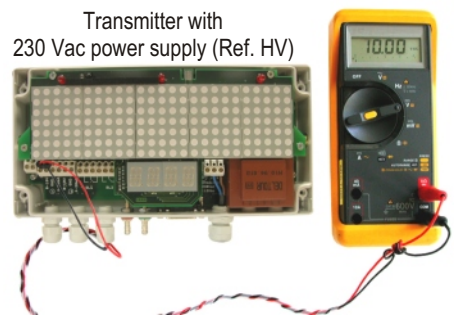
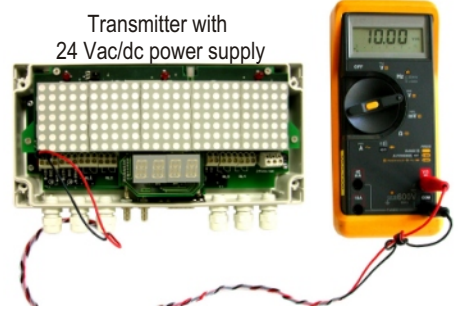
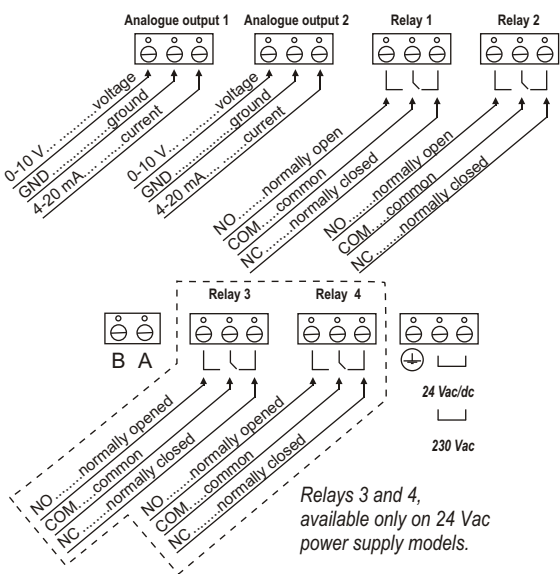



6.a.2 - Output diagnostics

Once the connection of the transmitter to the multimeter (or regulator or PLC/BMS is complete, see page 6), you can carry out the analogue output diagnostics on several check points.

Step 1



Go into configuration mode (see page 5). The folder number displayed corresponds to the last configuration folder used.

Select the folder "300" and validate with **OK**.

Step 2

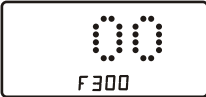

Channel n° 1 output

Select sub-folder "300"



Channel n° 2 output

Select sub-folder "303"



and validate with **OK**. The cursor > goes to available choices.

Step 3



With **+** and **-** keys, select the signal that the transmitter must output (see chart below). Note : no need to validate with **OK**.

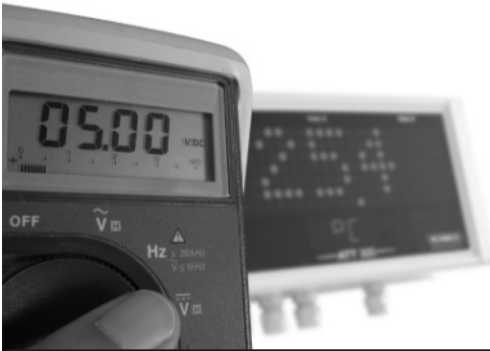

	Diagnostic Output
00	0 V
01	5 V
02	10 V
03	4 mA
04	12 mA
05	20 mA



If the deviations are too big (>0,05 V or >0,05 mA) between the signal issued and the value displayed on the multimeter, we recommend that you return the transmitter to our factory.

Step 4



The cursor > returns to sub-folders line.

- press twice **Esc** to return to reading mode.
- press once **Esc** to return to another folder selection.
- with **+** and **-** keys to choose another sub-folder from the folder 300.



6.b - Analogue output settings

With this function, you can modify the measuring range of the transmitter, and you can equate the new limits to the analogue output (0-10 V or 4-20 mA).

You can enter the measuring range required on your own !



You must enter the values according to the units of measurement selected, not according to the measuring range of the transmitter.

Eg. on a CPA303 pressure transmitter (0 to ±1000 Pa) with a reading in mmH₂O, the minimum and maximum ranges must be configured on measuring range of 0 to ±102 mmH₂O. See **conversion chart on following page**.

Step 1



Go into configuration mode (see page 5). The folder number displayed corresponds to the last configuration folder used.

Select the folder "300" and validate with **OK**.

Step 2

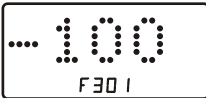

Minimum of Channel n°1 output

Select sub-folder "301"



Minimum of Channel n°2 output

Select sub-folder "304"



and validate with **OK**. The cursor > returns to the input line.

Step 3



With **+** and **-** keys, select the value sign : negative or positive, validate with **OK**. Then, enter the minimum limit value and validate with **OK**.

Step 4



Maximum of Channel n°1 output

Select sub-folder "302"



Maximum of Channel n°2 output

Select sub-folder "305"



and validate with **OK**. The cursor > goes to the input line.

Step 5



With **+** and **-** keys, select the value sign : negative or positive, validate with **OK**.

Then, enter the maximum limit value and validate with **OK**.



We recommend that the interval between the minimum and maximum is **> 5% of the measuring range**.

Step 6



The cursor > goes to sub-folders line.

- press twice **Esc** to return to reading mode.
- press once **Esc** to return to another folder selection.
- with **+** and **-** keys you can choose another sub-folder from the folder 300.



After an analogue output setting, if the unit of measurement is modified (see page 5), you have to reconfigure the outputs according to the new unit of measurement.



6.b.1 - Units of measurement conversion chart

Pressure

	<i>Pa</i>	<i>mmH2O</i>	<i>inWg</i>	<i>mbar</i>	<i>mmHg</i>
CPA 301	0 à ±100	0 à ±10,2	0 à ±0,401	0 à ±1,00	-
CPA 302	0 à ±500	0 à ±51,0	0 à ±2,005	0 à ±5,00	-
CPA 303	0 à ±1000	0 à ±102,0	0 à ±4,015	0 à ±10,00	-
CPA 304	0 à ±10000	0 à ±1020,0	0 à ±40,01	0 à ±100,00	0 à ±75,00

Pressure

	<i>Pa</i>	<i>mmH2O</i>	<i>inWg</i>	<i>mbar</i>	<i>mmHg</i>
CPA 301HV	0 à ±100	0 à ±10,2	0 à ±0,401	0 à ±1,00	-
CPA 302HV	0 à ±500	0 à ±51,0	0 à ±2,005	0 à ±5,00	-
CPA 303HV	0 à ±1000	0 à ±102,0	0 à ±4,015	0 à ±10,00	-
CPA 304HV	0 à ±10000	0 à ±1020,0	0 à ±40,01	0 à ±100,00	0 à ±75,00

Temperature

	<i>°C</i>	<i>°F</i>
THA 300 - St. steel probe	-40,0 à +180,0	-40,0 à +356,0
THA 300 - Probe PC	-20,0 à +80,0	-4,0 à +176,0

Temperature

	<i>°C</i>	<i>°F</i>
THA 300HV - St. steel probe	-40,0 à +180,0	-40,0 à +356,0
THA 300HV - Probe PC	-20,0 à +80,0	-4,0 à +176,0



7.a - Activation / Deactivation of BEEP alarm

The beep alarm (audible alarm) is activated when a set point is reached.
For more details on the setpoint settings, see page 20.

Step
1



Go into configuration mode (see page 5). The folder number displayed corresponds to the last configuration folder used.
Select the folder "400" and validate with

Step
2

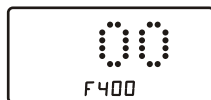

Select sub-folder "400" and validate with .
The cursor > goes to available choices.



Step
3

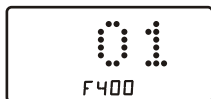

With and keys, select 01 to **activate** the BEEP alarm or 00 to **deactivate**. Validate with .

Step
4

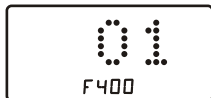

The cursor > goes to sub-folders line.

- press twice to return to reading mode.
- press once to return to another folder selection.
- with and keys you can choose another sub-folder from the folder 400.

7.b - Relay security

The relay outputs are by default, in **negative security**: the relay is **energized** when a set point is reached.
With the keypad, you can swap the relays in **positive security**: then, the relay is **de-energized** when a set point is reached or during a power outage.

Step
1



Enter in configuration mode (see page 5). The folder number displayed corresponds to the last configuration folder used.
Select folder "400" and validate with .

Step
2



Select sub-folder "401" and validate with .
The cursor > goes to available choices.



Step
3



With the keys and , select 01 for a **positive** security or 00 for a **negative** security. Validate with .

Step
4



The cursor > returns to sub-folders line.

- press twice on to return to reading mode.
- press once on to return to another folder selection.
- with and keys, you can choose another sub-folder from the folder 400.



7.c - Alarm / relay functions and LED colour codes

CPA300 & THA 300 transmitters have **4 relays** visible on the transmitter board with 24 Vac/dc power supply model (2 relays visible on the transmitter board with 230 Vac power supply model Ref.HV). Each relay has one LED to allow **real-time checking**.

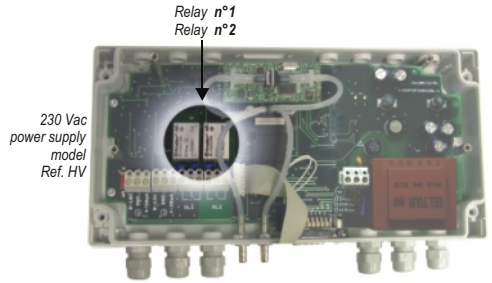
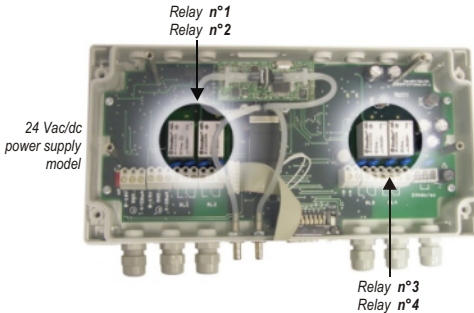

Relay LED colour codes

Red	The relay is energized
None	The relay is not energized or has not been configured



NOTE The relay is energized when the setpoint is reached, taking into account the time-delay, the action type and also the alarms security mode. Set points, time-delay and action type setting : see page 17
Alarm security settings : see page 12

7.d - Selection of the channel for visual and relays alarms

CPA300 & THA 300 transmitters have **4 audible relay alarms** with 24 Vac power supply model (2 audible alarms with 230 Vac power supply model Ref.HV). The transmitter can be configured with **4 different alarms setups** with 24 Vac/dc power supply model (2 audible alarms setups with 230 Vac power supply model Ref.HV).



Before any alarm setup, check that the corresponding channel(s) is activated.

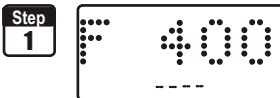

Go into configuration mode (see page 5). The folder number displayed corresponds to the last configuration folder used.

Select the folder "400" and validate with **OK**. Select sub-folder :

Available only on 24 Vac/dc power supply models.



"402" **Modbus 804**
Relay 1
(LED 1)

"407" **Modbus 814**
Relay 2
(LED 2)

"412" **Modbus 824**
Relay 3

"417" **Modbus 834**
Relay 4

and validate with **OK**.



With **+** and **-** keys, select the channel number for which you want to configure an alarm. Validate with **OK**.



The cursor **>** returns to sub-folders line.

- press twice **ESC** to return to reading mode.
- press once **ESC** to return to another folder selection.
- with **+** and **-** keys, you can choose another sub-folder from the folder 400 (i.e. for example to configure another alarm / relay)



7.e - Alarm mode details

7.e.1 - Definitions

Setpoint

The setpoint is a limit which, on being reached and/or exceeded, activates an alarm or energizes a relay (in negative security, see page 14 for more details).

Time-delay

Once the setpoint is reached and/or exceeded, the time-delay postpones the alarm activation (or relay excitation) for a short period (in seconds). Once this period is elapsed, and if the setpoint is still exceeded, then the alarm is activated or the relay is energized (in negative security).

Action type

For alarm activation or relay excitation, you can choose the action type : rising or falling action.

- **Rising action** : the alarm is activated once the measurement **goes over** the setpoint
- **Falling action** : the alarm is activated once the measurement **goes below** the setpoint

7.e.2 - Available configurations

Configuration N°1 : 2 setpoints and time-delay activated (Control Mode)

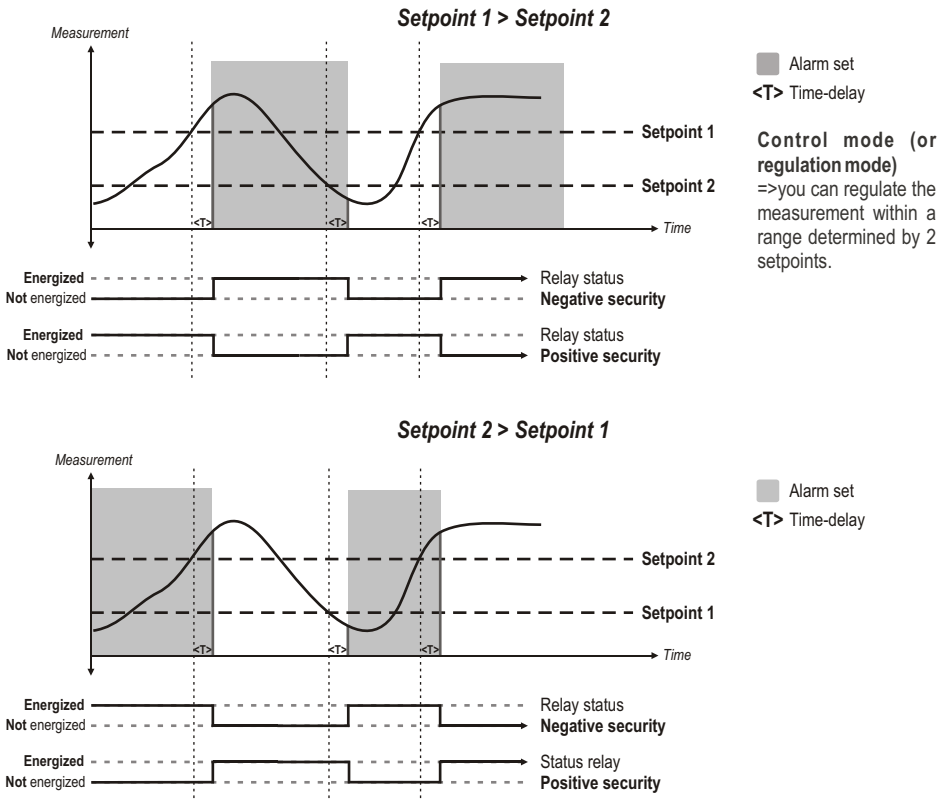



Configuration N°2 : 1 setpoint, time-delay and rising action activated

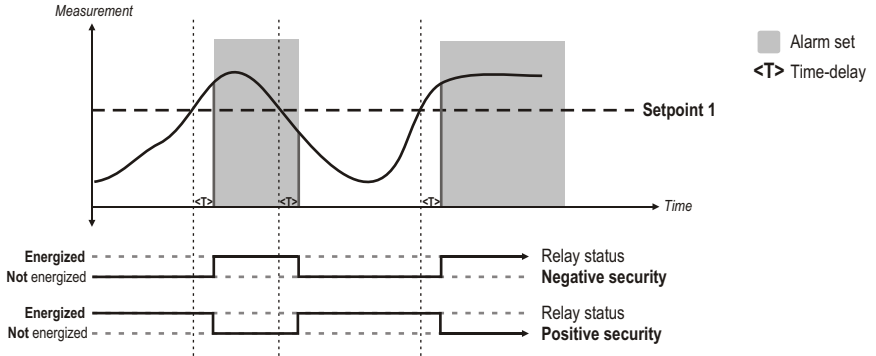

Configuration N°3 : 1 setpoint, time-delay and falling action activated

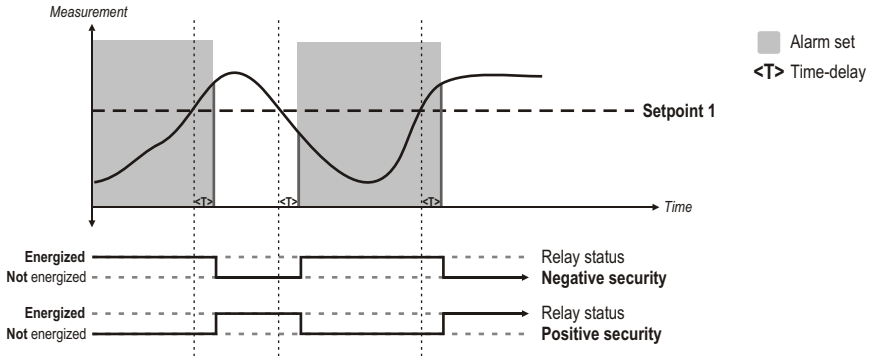



7.f - Alarm mode selection

Step
1



Go into configuration mode (see page 5). The folder number displayed corresponds to the last configuration folder used.

Select the folder "400" and validate with **OK**.

Select sub-folder

Step
2

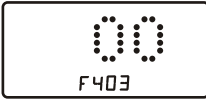

"403" Modbus
Relay 1 **806**

"408" Modbus
Relay 2 **816**

"413" Modbus
Relay 3 **826**

"418" Modbus
Relay 4 **836**

Available only on 24 Vac/dc power supply models.

and validate with **OK**.

Step
3



With **+** and **-** keys, select the code relative to the alarm mode (see chart below). Validate with **OK**.

Code	Alarm mode	Drawing
00	No alarm	
01	2 setpoints with time-delay (control mode)	N° 1 page 14
02	1 setpoint with time-delay and rising action	N° 2 page 15
03	1 setpoint with time-delay and falling action	N° 3 page 15

Step
4



The cursor **>** returns to sub-folders line.

- press twice **Esc** to return to reading mode.
- press once **Esc** to return to another folder selection.
- with **+** and **-** keys, you can choose another sub-folder from the folder 400.



7.g - Setpoints and time-delay setting

7.g.1 - Setpoints

Step
1



Go into configuration mode (see page 5). The folder number displayed corresponds to the last configuration folder used.

Select the folder "400" and validate with **OK**.

To configure the **setpoint 1**, select sub-folder

Step
2

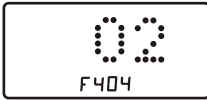

Available only on 24 Vac/dc power supply models.



and validate with **OK**.

To configure the **setpoint 2** (alarm in control mode, see p17), select sub-folder

Available only on 24 Vac/dc power supply models.



and validate with **OK**.

Step
3



With **+** and **-** keys, select the value sign : negative or positive.

Validate with **OK**.

Then, enter the setpoint value and validate with **OK**.



You must enter values according to the units of measurement selected, not according to the measuring range of the transmitter.

Ex. on a CPA 303 pressure transmitter (0 to ± 1000 Pa) with a reading in mmH₂O, the minimum and maximum ranges must be configured on measuring range of 0 to ± 102 mmH₂O. See conversion chart on page 11.

Step
4



The cursor **>** returns to sub-folders line.

- press twice **ESC** to return to reading mode.
- press once **ESC** to return to another folder selection.
- with **+** and **-** keys, you can choose another sub-folder from the folder 400.

NOTE

If after having set up a setpoint, the unit of measurement is modified (see page 9), then you have to reconfigure the setpoints according to this new unit of measurement.



7.g.2 - Time-delay

Step 1



Go into configuration mode (see page 5). The folder number displayed corresponds to the last configuration folder used.

Select the folder "400" and validate with **OK**.

Select sub-folder

Step 2



"406"
Relay 1



"411"
Relay 2



"416"
Relay 3



"421"
Relay 4



Available only on 24 Vac/dc power supply models.

and validate with **OK**.

Step 3



With **+** and **-** keys, set the required time-delay: from 00 to 60 seconds. If you do not need the time-delay, enter 00.

Validate with **OK**.

Step 4

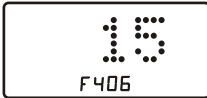

The cursor **>** returns to sub-folders line.

- press twice **Esc** to return to reading mode.
- press once **Esc** to return to another folder selection.
- with **+** and **-** keys, you can choose another sub-folder from the folder 400.



8.a - Pressure measurement integration (CPA 300)

The integration coefficient makes an average of the measurements : this helps to avoid any excessive variations and guarantees a stable measurement.

New value displayed = $[(10 - \text{Coef.}) \times N^{\text{th}} \text{ Value}] + (\text{Coef.} \times \text{former value}) / 10$

This value is applicable when the variation is **less than +/- (Coef. x 10 Pa)**

Example : CPA 303 (0-1000 Pa) - First measurement : 120 Pa - New measurement : 125 Pa

The pressure source is stable, the user applied a low integration. Integration : 1, maximum variation allowed +/-10 Pa. Since the variation is less than 10 Pa, we apply the integration calculation formula. Next measurement displayed $((9 \times 125) + (1 \times 120)) / 10 = 124.5$ soit 124 Pa. If the new value had been 131 Pa, the next value displayed would have been 100% of the new value, i.e 131 Pa.

Step
1



Go into configuration mode (see page 5). The folder number displayed corresponds to the last configuration folder used. Select the folder "500" and validate with **OK**.

Step
2

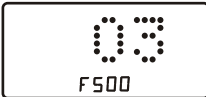

Select the sub-folder "500" and validate with **OK**.
The cursor > returns to available choices.



Step
3



With **+** and **-** keys, you can set the integration value: from 00 to 09. Validate with **OK**.

Coefficient 0 : no integration, large variation of the measurement displayed.
Coefficient 9 : maximum integration, more stable measurement display.

Step
4



The cursor > returns to sub-folders line.
• press twice **ESC** to return to reading mode.
• press once **ESC** to return to another folder selection.
• with **+** and **-** keys, you can choose another sub-folder from the folder 500.

8.a - Time-delay between 2 self-calibrations

Step
1



Go into configuration mode (see page 5). The folder number displayed corresponds to the last configuration folder used. Select the folder "500" and validate with **OK**.

Step
2



Select the sub-folder "501" and validate with **OK**.
The cursor > goes to available choices.



Step
3



With **+** and **-** keys, you can set the time-delay values between 2 self-calibrations : from 0 to 60 minutes. Validate with **OK**.

Nota : if the value is equal to 0, the transmitter will not carry out any self-calibration.

Step
4



The cursor > returns to sub-folder line.
• press twice **ESC** to return to reading mode.
• press once **ESC** to return to another folder selection.
• with **+** and **-** keys, you can choose another sub-folder from the folder 500



Whenever you want, in reading mode, you can carry out a self-calibration by keeping "ESC" pressed for 5 seconds.



9.a - Offset setting in humidity and temperature

In order to compensate for any longterm drift of the transmitter, you can add an offset to the value displayed by the THA 300 with the EHK 500 reference portable instrument or via the keypad.



Function only available on humidity transmitter types **THA 300**



The EHK 500 is a reference portable instrument (optional) which enables you to adjust at one point the humidity and temperature reading, via the RS 232 connection cable. Thanks to this new time-saving system, no need to return the transmitter to our factory.

Your transmitter is always available on site. For more details, see technical datasheet and user manual of EHK

9.a.1 - Offset in hygrometry

Step
1



Go into the configuration mode (see page 5). The folder number displayed corresponds to the last folder used.

Select folder "500" and validate with **OK**.

Step
2



Select sub-folder "500" and validate with **OK**.

The cursor **>** goes to the line of available choices.



Step
3



With keys **+** and **-**, enter the offset value : from -50.0 to $+50.0$.
Validate with **OK**.

The cursor **>** returns to sub-folders line.

- press once on **Esc** to return to reading mode.
- or choose another folder to access other functions.

9.a.2 - Offset in temperature

Step
1



Go into the configuration mode (see page 2). The folder number displayed corresponds to the last folder used.

Select folder "500" and validate with **OK**.

Step
2



Select sub-folder "501" for an offset in $^{\circ}\text{C}$ or "502" for an offset in $^{\circ}\text{F}$ and validate with **OK**.

The cursor **>** goes to the line of available choices.



With keys **+** and **-**, enter the offset value : from -50.0 to $+50.0$ (in $^{\circ}\text{C}$) or from -90 to $+90$ (in $^{\circ}\text{F}$). Validate with **OK**.

Step
3



The cursor **>** returns to sub-folders line.

- press twice **Esc** to return to reading mode.
- press once **Esc** to return to another folder selection.
- with **+** and **-** keys, you can choose another sub-folder from the folder 500



If you activate the offset in temperature in $^{\circ}\text{C}$ (function 501), the value entered is automatically converted into $^{\circ}\text{F}$ (function 502) and vice versa.



10.a - Temperature compensation

You can **modify the temperature compensation value**.

The air velocity and airflow measured with a differential probe (such as Pitot tube, Debimo blade, orifice plate...) depends on the working temperature. Then, it is required to enter the **working temperature** to get more accurate results. You can enter the value either manually or using a thermocouple K probe which offers the automatic temperature compensation.



Function only available on pressure transmitter types **CPA 300 with SQR option**

10.a.1 - Manual compensation

Step
1



Go into configuration mode (see page 5). The folder number displayed corresponds to the last configuration folder used.

Select the folder "600" and validate with **OK**.

Step
2

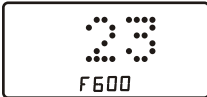

Select the sub-folder "600" to enter a value in °C

or "601" to enter a value in °F

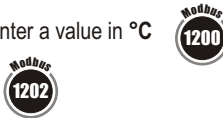

validate with **OK**. The cursor > returns to available choices.

Step
3



With **+** and **-** keys, enter the temperature compensation (Celsius degree shown alongside, sub-folder "600"). Validate with **OK**.

NOTE

If you make a temperature compensation in Celsius degree (sub-folder "600"), the transmitter will automatically make the conversion into Fahrenheit degree (sub-folder "601") and vice versa.



10.b - Air velocity coefficient selection (CPA 300)

Since the air velocity is calculated from the pressure (on a CPA300) and from a differential probe, **you must enter the coefficient value of the differential probe.** For Pitot tubes and Debimo blades, the coefficient is already included in the transmitter.

Function only available on the pressure transmitter types **CPA 300 with SQR option**

Step 1

Go into configuration mode (see page 5). The folder number displayed corresponds to the last configuration folder used.
Select the folder "600" and validate with .

Step 2

Select the sub-folder "603" and validate with .
The cursor \blacktriangleright goes to available choices.



Step 3

With \oplus and \ominus keys, select the differential probe type. Validate with .

Code	Differential probe	Coef.
00	Pitot tube L (ISO 3966)	1
01	DEBIMO blade	0.8165
02	Other differential probe	To be entered

Step 4

The cursor \blacktriangleright returns to sub-folders line.

- press twice to return to reading mode.
- press once to return to another folder selection.
- with \oplus and \ominus keys, you can choose another sub-folder from the folder 600.

If you use "Other differential probe" please carefully follow the instructions below.

10.b.1 - Manual coefficient input

Step 1

Select the folder "600" and validate with .
Select the sub-folder "604" and validate with .
The cursor \blacktriangleright goes to available choices.



Step 2

With \oplus and \ominus keys, **enter the coefficient relative to your differential probe.** This coefficient is given by the manufacturer (from 0.0001 to 9.9999).
Validate with .

Step 3

The cursor \blacktriangleright returns to sub-folders line.

- press twice to return to reading mode.
- press once to return to another folder selection.
- with \oplus and \ominus keys, you can choose another sub-folder from the folder 600.



10.c- Air velocity coefficient input

With this correction coefficient, you can adjust the transmitter according to the air velocity in your installation.



Function only available on the transmitter types **CPA 300 with SQR option**

10.c.1 - How to calculate it ?

If the air velocity in your duct is equal to **17 m/s**, and if the transmitter indicates **16.6 m/s**, then the coefficient to apply is $17 / 16,6$ ie **1.024**

10.c.2 - Coefficient input

Step
1



Go into configuration mode (see page 5). The folder number displayed corresponds to the last configuration folder used.

Select the folder "600" and validate with **OK**.

Step
2



Select the sub-folder "605" and validate with **OK**.
The cursor \rightarrow goes to available choices.



Step
3



With **+** and **-** keys, **enter the coefficient value** calculated (from 0.200 to 2.000). Validate with **OK**.

Step
4



The cursor \rightarrow returns to the sub-folders line.

- press twice **ESC** to return to reading mode.
- press once **ESC** to return to another folder selection.
- with **+** et **-** keys, you can choose another sub-folder from the folder 600.



11.a - Selection of duct section type or airflow coefficient

11.a.1 - Working from the section type



Function only available on pressure transmitter types CPA 300 with SQR option

Step 1



Go into configuration mode (see page 5). The folder number displayed corresponds to the last configuration folder used.

Select the folder "600" and validate with **OK**.

Step 2



Select the sub-folder "606" and validate with **OK**.
The cursor > goes to available choices.



Step 3



With **+** and **-** keys, select the section type (00 or 01).
Validate with **OK**.

Code	Section type
00	Rectangular
01	Circular
02	Airflow coefficient (to be entered, see p 25)

Step 4



The cursor > returns to sub-folders line.

- press twice **Esc** to return to reading mode.
- press once **Esc** to return to another folder selection.
- with **+** and **-** keys to choose another sub-folder from the folder 600.

Section sizes input

Step 1



Go into configuration mode (see page 5). The folder number displayed corresponds to the last configuration folder used.

Select the folder "600" and validate with **OK**.

Step 2



Select sub-folder

Rectangular section

Circular section

	Rectangular section		Circular section
	Length	Width	Diameter
mm	"607"	"608"	"609"
inch	"610"	"611"	"612"

and validate with **OK**.



Step 3



With \oplus and \ominus keys, enter the value (from 0 to 3000 mm or 0 to 118.11 inch). Validate with OK .

Step 4



The cursor \triangleright returns to sub-folders line.
• press twice Esc to return to reading mode.
• press once Esc to return to another folder selection.
• with \oplus and \ominus keys, you can choose another sub-folder from the folder 600.

NOTE

If you enter a length, width or diameter in mm, the transmitter will automatically calculate the conversion in Inch (vice versa)

10.a.2 - Working from a airflow coefficient

With this coefficient, you can calculate the airflow from the pressure. This coefficient is given by the manufacturer of the devices supplied with pressure connections (+ and -). From the square root of the pressure measured (Delta P), and from this coefficient, you get the airflow.

$$\text{Airflow} = C_p \times \sqrt{\Delta \text{Pressure}}$$



Function only available for the pressure transmitter types **CPA 300 with SQR option**. In this calculation mode, you have **no access to reading of air velocity**. If you activate this calculation mode and also a channel in air velocity, the transmitter will display an error code "4".



Go back to procedure page 24 / step 3:

With \oplus and \ominus keys, select 02 and validate with OK .

Step 1



Go into configuration mode (see page 5). The folder number displayed corresponds to the last configuration folder used. Select the folder "600" and validate with OK .

Step 2



Select the sub-folder "613" and validate with OK . The cursor \triangleright goes to available choices.



Step 3



With \oplus and \ominus keys, enter the airflow coefficient value (from 0,01 to 999,99). Validate with OK .

Step 4



The cursor \triangleright returns to sub-folders line. Select the sub-folder "614" to select the **unit of measurement in pressure** for the airflow calculation and validate with OK .





Step
5



With \oplus and \ominus keys, select the unit of measurement (see chart below).
Validate with OK .

	<i>CPA301, 302 et 303 CPA301HV, 302HV et 303HV</i>	<i>CPA304 CPA304HV</i>
01	Pa	Pa
02	mmH ₂ O	mmH ₂ O
03	inWg	inWg
04	mbar	mbar
05	-	mmHg

Step
6



The cursor \rightarrow returns to sub-folders line.

- press twice Esc to return to reading mode.
- press once Esc to return to another folder selection.
- with \oplus and \ominus keys to choose another sub-folder from the folder 600.



12.a- Activation / deactivation of the RS232 and home bus

CPA300 & THA 300 transmitters have one RS 232 and one RS 485 digital output (Modbus protocol) - optional. With the RS 232, you can display 1 or 2 parameters which are measured by other Class 200 and 300 transmitters, or you can send measurements to be displayed on another Class 300 transmitters.

! If you set up your transmitter to send measurements to another transmitter via RS 232, then you will not be able to use the RS 485 digital output anymore (Modbus - optional).

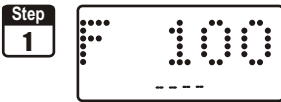

Go into configuration mode (see page 5). The folder number displayed corresponds to the last configuration folder used.

Select the folder "100" and validate with **OK**.

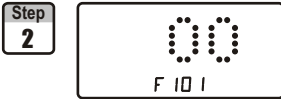

Select the sub-folder "101" and validate with **OK**.



With **+** and **-** keys, select **100** to receive data from another transmitter or select **1** to send data via RS 232. Validate with **OK**.
CAUTION!!

When the transmitter is configured to **receive data**, then the RS 485 Modbus is **active**. When the transmitter is configured to **send data** via RS 232, then the RS 485 Modbus is **inactive**.



The cursor **>** returns to sub-folders line.

- press twice **Esc** to return to reading mode.
- press once **Esc** to return to another folder selection.
- with **+** and **-** keys, you can choose another sub-folder from the folder 100.

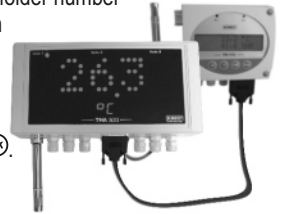

12.b- Serial number display

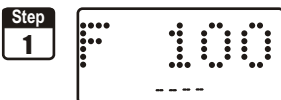

Go into configuration mode (see page 5). The folder number displayed corresponds to the last configuration folder used.

Select the folder "100" and validate with **OK**.



Select the sub-folder "102" and validate with **OK**.



The serial number of the transmitter is displayed. The cursor **>** returns to sub-folders line.

- press twice **Esc** to return to reading mode.
- press once **Esc** to return to another folder selection.
- with **+** and **-** keys to choose another sub-folder from the folder 100.



12.c- Modification of Modbus communication speed

Step 1



Go into configuration mode (see page 5). The folder number displayed corresponds to the last configuration folder used. Select the folder "100" and validate with **OK**.

Step 2

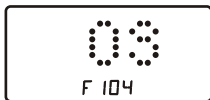

Select the sub-folder "104" and validate with **OK**.



Step 3

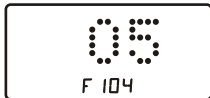

With **+** and **-** keys, select a communication speed (see chart below). Validate with **OK**.

00	2400 bauds	03	19200 bauds (speed by default)
01	4800 bauds	04	38400 bauds
02	9600 bauds	05	115200 bauds

Step 4

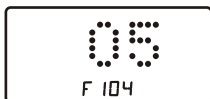

The cursor **>** returns to sub-folders line.

- press twice **Esc** to return to reading mode.
- press once **Esc** to return to another folder selection.
- with **+** and **-** keys, you can choose another sub-folder from the folder 100.



12.d- Purge mode

The purge mode enables to freeze the measurement when being displayed, enables to lock the analogue outputs, and to activate the relay 1, in order to actuate a de-dust system of a air movement conditions.



This function is only available on **CPA 300** pressure transmitters.

12.d.1-Activation / deactivation of Purge Mode

Step
1



Go into configuration mode (see page 5). The folder number displayed corresponds to the last configuration folder used.

Select the folder "300" and validate with **OK**.

Step
2



Select the sub-folder "306" and validate with **OK**.



Step
3



With **+** and **-** keys, activate (**01**) or deactivate (**00**) the purge mode. Validate with **OK**.

Step
4



The cursor **>** returns to sub-folders line.

- press twice **Esc** to return to reading mode.
- press once **Esc** to return to another folder selection.
- with **+** and **-** keys, choose another sub-folder from the folder 300

12.d.2 -Working duration of purge mode

Step
1



Go into configuration mode (see page 5). The folder number displayed corresponds to the last configuration folder displayed.

Select the folder "300" and validate with **OK**.

Step
2



Select the sub-folder "307" and validate with **OK**.



Step
3



With **+** and **-** keys, enter the value in seconds of the required working duration of each purge (from **01** to **60**). Validate with **OK**.

Step
4



The cursor **>** returns to sub-folders line.

- press twice **Esc** to return to reading mode.
- press once **Esc** to return to another folder selection.
- press **+** and **-** to choose another sub-folder from the folder 300



12.d- Mode Purge

12.d.3 -Frequency

Step 1



Go into configuration mode (see page 5). The folder number displayed corresponds to the last configuration folder used. Select the folder "300" and validate with **OK**.

Step 2



Select the sub-folder "308" and validate with **OK**.

Step 3



With keys **+** and **-**, enter the value in minutes of the frequency of each purge (from 01 to 9999). Validate with **OK**.



Step 4



The cursor **>** returns to sub-folders line.
• press twice **Esc** to return to reading mode.
• press once **Esc** to return to another folder selection.
• with **+** and **-**, choose another sub-folder from the folder 300.

12.d.4 - Time-delay

Once the purge is finished, time-delay is a time period before the transmitter returns to measurement mode and before the analogue outputs are reactivated.

Step 1



Go into configuration mode (see page 5). The folder number displayed corresponds to the last configuration folder used. Select the folder "300" and validate with **OK**.

Step 2



Select the sub-folder "309" and validate with **OK**.



Step 3



With **+** and **-** keys, enter the value in seconds of the time-delay required (from 00 to 655). Validate with **OK**.

Step 4



The cursor **>** returns to the sub-folders line.
• press twice **Esc** to return to reading mode.
• press once **Esc** to return to another folder selection.
• with **+** and **-** keys, choose another sub-folder from the folder 300.



13. Error codes

Code	Problem	Solution
01	Configuration error (alarm(s) set on a non displayed/activated channel)	<ul style="list-style-type: none">• Check status of the 4 alarms (or 2 alarms for Ref.HV) and 4 channels. Ex. : the error appears if an alarm is configured on a channel (1, 2, 3 or 4) which is not active. Then, you must activate the channel on which you want to configure an alarm. <p>Activation of a channel : see page 5</p> <p>Alarm and relay configurations : see page 14</p>
02	No channel activated	<ul style="list-style-type: none">• Activate one channel (at least). <p>Activation of a channel : see page 5</p>
03	Humidity probe (THA 300) or SPI (CPA300) not connected	<ul style="list-style-type: none">• Connect the probe / SPI (see user manual SPI)
04	Only on CPA 300. A channel is configured in air velocity (see page 5) and the airflow calculation function (page 23) is set to 02 (airflow coefficient). This combination is impossible .	<ul style="list-style-type: none">• Select a unit in airflow for the channel 1, 2, 3 or 4 (see channels configuration, page 5)• Instead of airflow coefficient, select a circular or rectangular section in function 606 (see page 24)



F100

Code

Description

Available settings

100	200	Channel n° for IR remote control
101	202	Sending data via RS 232
102	204	Serial number display
103	206	Modbus slave number
104	208	Modbus communication speed

0 to 9

0 or 1

1 to 255

00	2400 bds	02	9600 bds	04	38400 bds
01	4800 bds	03	19200 bds	05	115200 bds

F200

Code

Description

200	400	Unit of channel 1
201	402	Unit of channel 2
202	404	Unit of channel 3
203	406	Unit of channel 4

Available settings

	<i>CPA301, 302 et 303 CPA301HV, 302HV et 303HV</i>	<i>CPA304 CPA304HV</i>	<i>THA300 THA300HV</i>
00	Inactive channel	Inactive ch.	Inactive channel
01	Pa	Pa	°C
02	mmH ₂ O	mmH ₂ O	°F
03	inWg	inWg	%HR
04	mbar	mbar	g/Kg (Hygro. absolue p)
05	m/s	mmHg	°C (Temp. de rosée Td)
06	fpm	m/s	°F (Temp. de rosée Td)
07	m ³ /h	fpm	°C (Temp. humide Tw)
08	L/s	m ³ /h	°F (Temp. humide Tw)
09	cfm	L/s	KJ/Kg (Enthalpie l)
10	m ³ /s	cfm	
11		m ³ /s	



F300

	Code		Description	Available settings
channel 1	300	600	Analogue output setting on channel 1	0=>0V, 1=>5V, 2=>10V 3=>4mA, 4=>12mA, 5=>20mA
	301	602	Analogue output minimum on channel 1	
	302	604	Analogue output maximum on channel 1	
channel 2	303	606	Analogue output setting on channel 2	0=>0V, 1=>5V, 2=>10V 3=>4mA, 4=>12mA, 5=>20mA
	304	608	Analogue output minimum on channel 2	
	305	610	Analogue output maximum on channel 2	
CPA 300	306	612	Activation / Deactivation of purge mode	00 or 01
	307	614	Working time of each purge	from 01 to 60 seconds
	308	616	Frequency of each purge	from 01 to 9999 minutes
	309	618	Time-delay after purge	from 00 to 60 seconds



F400

Available only on 24 Vac/dc power supply models

RELAY 1

Code	Modbus	Description	Available settings
400	800	Audible alarm	0 or 1
401	802	Relays security	0 (negative) or 1 (positive)
402	804	Channel selection for relay 1	1=> channel 1, 2=> channel 2, 3=>channel 3, 4=> channel 4
403	806	Channel selection for relay 1	0=> inactive 1=> setpoint 1, setpoint 2 and time-delay 2=> setpoint 1, time-delay and rising action 3=> setpoint 1, time-delay and falling action
404	808	Setpoint 1 of relay 1	
405	810	Setpoint 2 of relay 1	
406	812	Time-delay on relay 1	from 0 to 60 seconds

RELAY 2

407	814	Channel selection for relay 2	1=> channel 1, 2=> channel 2, 3=>channel 3, 4=> channel 4
408	816	Relay 2 type selection	0=> inactive 1=> setpoint 1, setpoint 2 and time-delay 2=> setpoint 1, time-delay and rising action 3=> setpoint 1, time-delay, and falling action
409	818	Setpoint 1 of relay 2	
410	820	Setpoint 2 of relay 2	
411	822	Time-delay on relay 2	from 0 to 60 seconds

RELAY 3

412	824	Channel selection for relay 3	1=> channel 1, 2=> channel 2, 3=>channel 3, 4=> channel 4
413	826	Alarm type selection for relay 3	0=> inactive 1=> setpoint 1, setpoint 2 and time-delay 2=> setpoint 1, time-delay and rising action 3=> setpoint 1, time-delay and falling action
414	828	Setpoint 1 of relay 3	
415	830	Setpoint 2 of relay 3	
416	832	Time-delay of relay 3	from 0 to 60 seconds

RELAY 4

417	834	Channel selection for relay 4	1=> channel 1, 2=> channel 2, 3=>channel 3, 4=> channel 4
418	836	Alarm type selection for relay 4	0=> inactive 1=> setpoint 1, setpoint 2 and time-delay 2=> setpoint 1, time-delay and rising action 3=> setpoint 1, time-delay and falling action
419	838	Setpoint 1 of relay 4	
420	840	Setpoint 2 of relay 4	
421	842	Time-delay of relay 4	from 0 to 60 seconds



14. Functions recap

F500

Code	Modbus XXX	Model	Description	Available settings
500	1000	CPA 300	Measurement integration	from 0 to 9
500	1000	THA 300	Offset in humidity	-50,0 to +50,0
501	1002	CPA 300	Self-calibration for time-delay	from 0 to 60 minutes
501	1002	THA 300	Offset in temperature (°C)	from -50,0 to +50,0
502	1004	THA 300	Offset in temperature (°F)	from -90,0 to +90,0

F600

Code	Modbus XXX	Description	Available settings
600	1200	Compensation temperature in °C	-
601	1202	Compensation temperature in °F	-
603	1206	Air velocity measurement mean	

Code	Differential probe
00	Pitot tube
01	DEBIMO blade
02	Other differential probe

604	1208	Air velocity coefficient value	from 0.0001 to 9.9999
605	1210	Air velocity correction coefficient	from 0.200 to 2.000
606	1212	Section type selection	

Code	Section type
00	Rectangular
01	Circular
02	Airflow coefficient

607	1214	Section length in mm	from 0 to 3000 mm
608	1216	Section width in mm	from 0 to 3000 mm
609	1218	Section diameter in mm	from 0 to 3000 mm
610	1220	Section length in inch	from 0 to 118.11 inch
611	1222	Section width in inch	from 0 to 118.11 inch
612	1224	Section diameter in inch	from 0 to 118.11 inch
613	1226	Airflow coefficient	from 0.01 to 999.99
614	1228	Units of pressure for the pressure calculation	

	CPA301, 302 et 303 CPA301HV, 302HV et 303HV	CPA304 CPA304HV
01	Pa	Pa
02	mmH ₂ O	mmH ₂ O
03	inWg	inWg
04	mbar	mbar
05	-	mmHg

CPA 300

CPA 300

www.kimo.fr

EXPORT DEPARTMENT

Boulevard de Beaubourg - Emerainville - BP 48
77312 MARNE LA VALLEE CEDEX 2

Tel : + 33.1.60.06.69.25 - Fax : + 33.1.60.06.69.29

